

Frigate Product Portfolio



Get Quote

CONTACT US

 **+91 94861 64606**

 **sales@frigate.ai**

 **frigate.ai**

Texas, USA | Trichy, Coimbatore, Pune India

Table of Contents

1	About Frigate	4
2	Cables & Wires	5
3	Connectors	8
4	Wiring Harness	10
5	Lugs	12
5	Hoses	14
6	LED Lights	16
7	Bus Bars	19
8	Enclosures and Switch Gears	21
9	Plastics & Rubbers	24
10	Switches	28
11	Extrusions	30
12	Heavy Engineering	33
13	Automotive Lighting	35
14	Valves, Flanges, Coupling, Spacers & Pipe Fittings	40
15	Fasteners	44
16	Automobile & After Market Parts	49
17	Solar Products	56
18	Brass Components	58

Table of Contents

19	Mechanical Parts	62
20	Packaging	65
21	Contract Manufacturing	68
22	EMS & Semiconductors	70

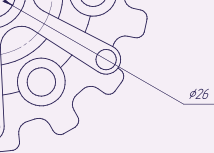

ABOUT FRIGATE

Frigate[®] is a B2B cloud manufacturing platform that offers a comprehensive suite of manufacturing services to medium and large-scale companies globally. Frigate is on a mission to "Make Manufacturing Easy" for Global Industrial OEM, ODM, and product companies by helping them convert their digital designs to physical products from sampling to full-scale manufacturing.

Industries

- ✓ Oil & Gas
- ✓ Automotive
- ✓ Energy & Infrastructure
- ✓ Medical
- ✓ Aerospace
- ✓ EV & Accessories

Services

- ✓ Cables & Wires
- ✓ Forgings
- ✓ Fabrication
- ✓ Injection Molding
- ✓ Castings
- ✓ 3D & metal printing

50+

Global Customers

50,000+

Parts Manufactured

100+

Manufacturing Facilities

OUR CLIENTALE



COUNTRIES WE EXPORTED TO



Expertise to ship to 100+ Countries and more

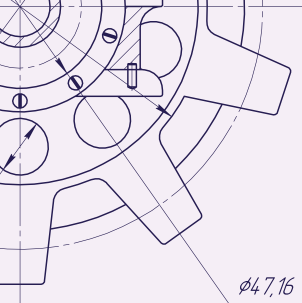

FRIGATE®
MANUFACTURING MADE EASY

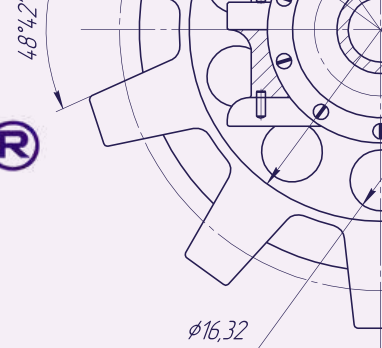

Cables & Wires



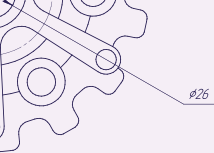

OUR PORTFOLIO | CABLES

Elastomer & E- Beam Cables



Electrical cables



Sea & Submarine Cables



Wind Mill Cables



Solar Cables



Trailing Cables



Mining Cable



CRD Cables



Uninyvin Cables



Welding Cables



Railway Locomotive cables

Light Duty Cables



Light Duty Cables & Wires



Flexible Copper Cables



Flexible Aluminium Cables



Submersible Cables



Automotive Cables



Battery Cables



LAN Cables



CCTV Cables

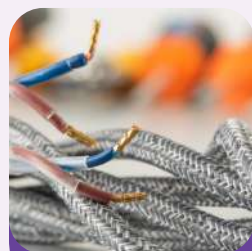

Braided Cables



Fire Alarm Cables

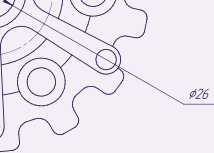

OUR PORTFOLIO | CABLES

Fiber Optics Cables



CATV cables



Unitube Cables



Multi-tube Cables



Breakout Tight Buffer Cables



Ribbon Cables



Single & Multi-Mode Cable



Fibre Festoon Cables



FITH Cables



Hybrid Copper & OF Cables



ADSS & Aerial cables

Speciality Products and services



Umbilical Cables



ROV Cables



Tether Cables



Torpedo Cables



Automotive Cables

Cable Accessories



Cable Gland A type



Cable Gland B Type



Cable Gland C Type



Cable Gland E Type



Heat Shrink Sleeve

Connectors



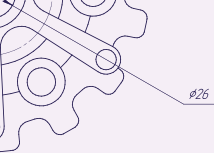

OUR PORTFOLIO | CABLES

Connectors



Square Flange Receptacle



Free - Hanging Receptacle



Plug



CPC Connectors,



Metal Square Flange Receptacle



Metal layer Plug



Compression Connector



BNC Connectors



RCA Connectors



D-Sub Connectors



RF Coaxial Connectors

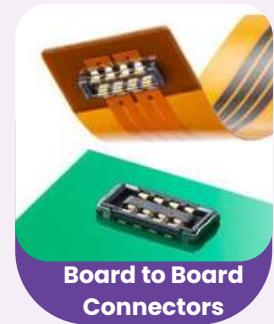

Board to Board Connectors



Cable Clamps



Cable Entry Seals



Ethernet Connector



XLR Connectors

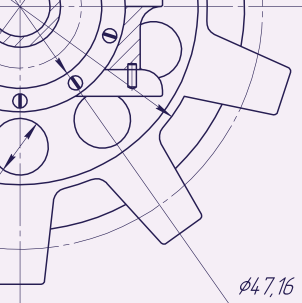

FRIGATE[®]
MANUFACTURING MADE EASY

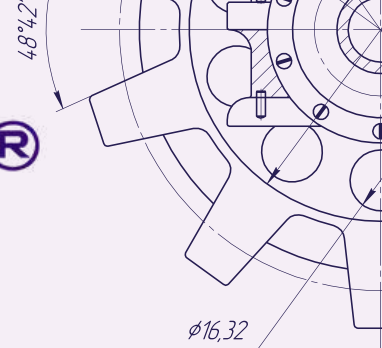

WIRING HARNESS



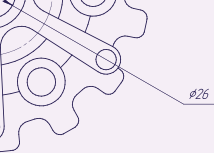

OUR PORTFOLIO

Wiring Harness



**Automotive
Wiring Harness**



**Elevator & Escalator
Wiring Harness**



**Control Panel
Wiring Harness**



**Medical Equipment
Wiring Harness**



**Home Appliances
Wiring Harness**



**Data Cable
Wiring Harness**



**Defence Wiring
Harness**



**Fuel Pump
Wiring Harness**



**Construction Equipment
Wiring Harness**



**Renewable Energy
Wiring Harness**



**UPS Cable
Harness**



**Telecom Wiring
Harness**

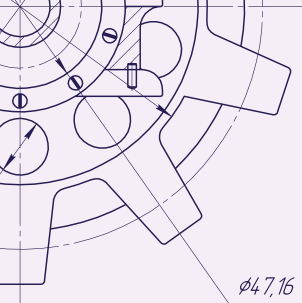

φ47,16

FRIGATE®

MANUFACTURING MADE EASY

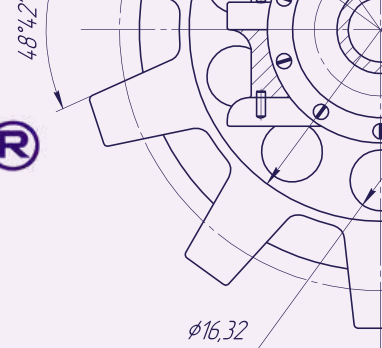

φ16,32

LUGS



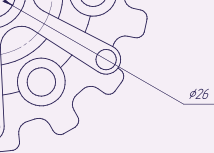

OUR PORTFOLIO | CABLE LUGS



Bimetallic Lugs



Tubular Terminal



Long Barrel tubular Terminal



inline Ferrule



End Sealing Ferrules



Ring Type Terminal



Ring Fork Type Terminal



Rectangular Fork Type Terminal



Pin Type Terminal Lug



Insulated Ferrules/ sealings

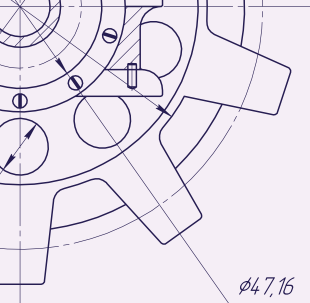

47,16

FRIGATE®

MANUFACTURING MADE EASY

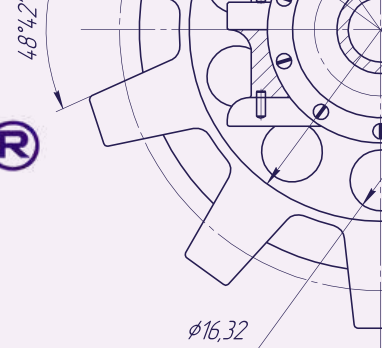

48,42
16,32

HOSES



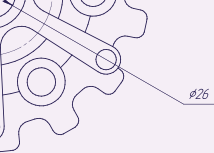

OUR PORTFOLIO | HOSES



Hydraulic Hose



Push lock-Push on
Hose



Cryogenic
Transfer Hose

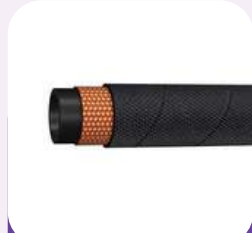

Air Brake Hoses



Fuel Hose



Suction
Hose



Air Hose



Water Hose



Chemical Hose



Coolant Hose



Food Grade
Hoses



Steam Hose



Dust collection
Hose



Metal Hose



PVC Suction
Hose



Welding
Hoses



Air duct Hose



Engine
Coolant Hose



Mining Hose



Pressure
Washer Hose

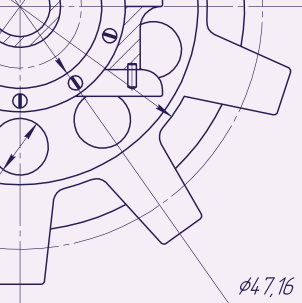

47,16

FRIGATE®

MANUFACTURING MADE EASY

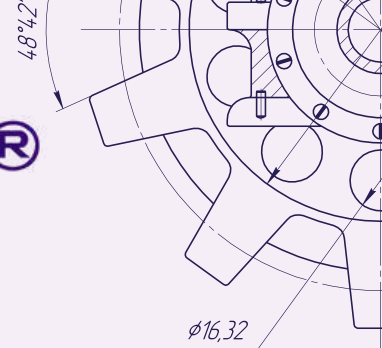

48,42
16,32

LED LIGHTS



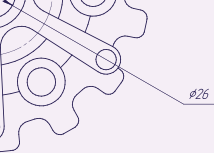

OUR PORTFOLIO

LED Street Light



LED Inverter Series



LED Slim Panels



LED Spot Lights



LED Battens - Crysta



UFO & Highbay Lights



Decorative Series - Rangoli



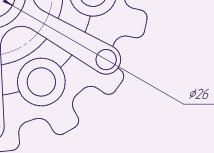

OUR PORTFOLIO

LED Flood & Down lights



LED Bulbs



Other Products - LED



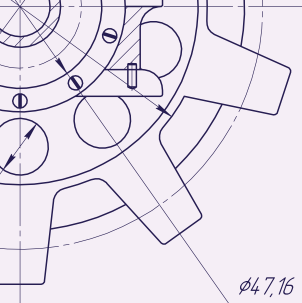

FRIGATE®
MANUFACTURING MADE EASY

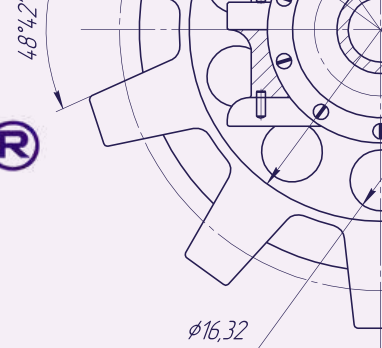

BUS BARS



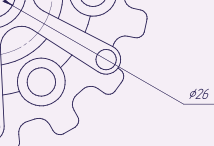

OUR PORTFOLIO | BUS BAR

Types of Bus Bars



Tin Plate Bus Bars

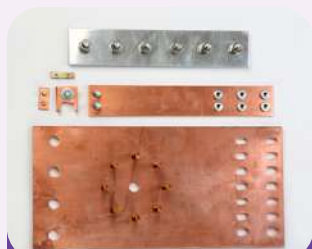

Bolted and Clinched Bus Bars

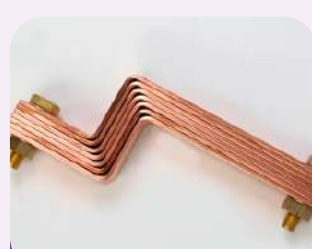

Laminated Bus Bars



Insulated Bus Bars



Bent Bus Bars



Fish Plates Bus Bars



Undrilled Bus Bars



Machined Bus Bars



Copper Bus Bars



Fork Type Bus Bars



Ribbon Type Bus Bars



Pin Type Bus Bars

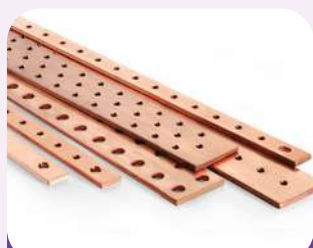

Stamped and Punched Bus Bars



Bent and Punched Bus Bars



3D - Bus Bars



Aluminum Bus Bars

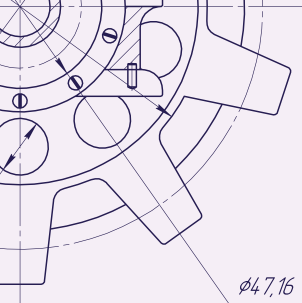

47,16

FRIGATE[®]

MANUFACTURING MADE EASY

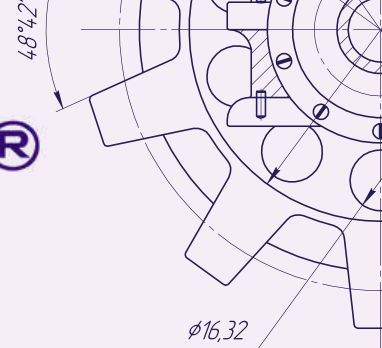

48,42

16,32

ENCLOSURES & SWITCHGEARS



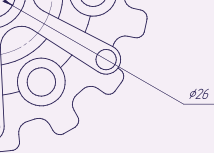

OUR PORTFOLIO

ENCLOSURES



Wall Mount Enclosures



Floor Mount Enclosures



Junction Box Enclosures



Push Button Enclosures



Wire-through Enclosures



Console & Consolets Enclosures



Sloped Top Enclosures



Disconnect Enclosures



Dual Access Enclosures



Flush Mount Enclosures



Windowed & Clear Cover Enclosures



MNX & ABS Enclosures



Solid PC/ABS Enclosures



Step Rail Series DIN Enclosure



IP65 Waterproof Hinged Enclosure



IP65 Waterproof GPS Enclosures

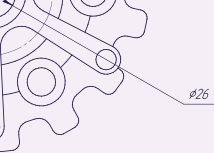

OUR PORTFOLIO

Enclosures & Switchgear



Aluminum Enclosures



Desktop Enclosure



Power Distribution Enclosures



Cardmaster Enclosures



Junction Box Enclosures



Wall Mounting Enclosures



Industrial Distribution Box



IP67 Fibre Reinforced Polyester Enclosure



Switchgears



Position Switches



Mini DC Circuit Breakers



RCBO circuit breaker



Electrical Cabinet Switch



SwitchGear Cabinet Components



Circuit Breakers



Astronomical Time Switch

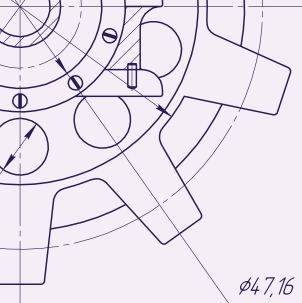

FRIGATE[®]
MANUFACTURING MADE EASY

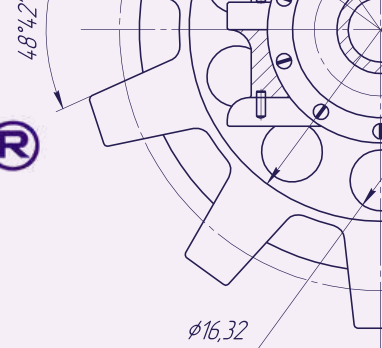

PLASTICS & RUBBER



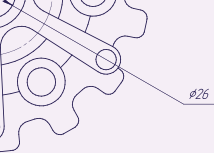

OUR PORTFOLIO | CONNECTORS , ENCLOSURES



**Push in
Connector**



**CPC
Connectors**



**Waterproof Bayonet
Connectors**



**Circular
Connector**



**PVC Pipe
connectors**



**Luer
Connector**



**Cover
Connector**



**Bellow Dust
Connector**



**Snap Fit
Connector**



**Threaded
Connector**



**Barbed
Connector**



**Bayonet
Connector**



**Belt-Tensioner
Pulleys**



**Interlocking
Connector**



**Modular
Connector**



Rear Panel



Bezel Cowl



**PA
Enclosure**

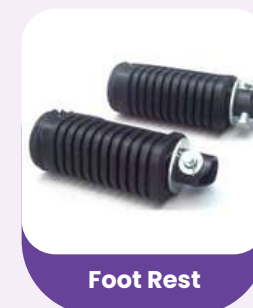

Foot Rest



Starter Gear

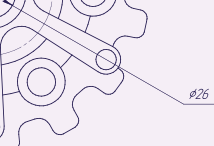

OUR PORTFOLIO | BUSHES, GASKETS & HAND WHEEL



Nylon tube Bush



PTFE Tube Bush



UHWE Bush



Rubber Bushes

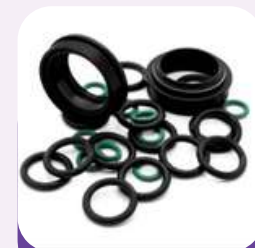

Elastomer Gskets



Breaded Gaskets



Cover Valve Gaskets



Bumper Bush



Rubber Boot Ring

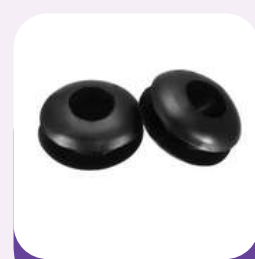

Grommets



Two Stoke Hand Wheel

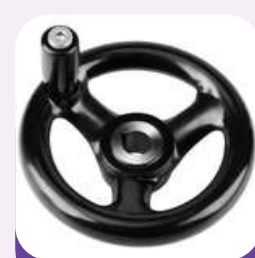

Ankled Spoke Hand Wheel

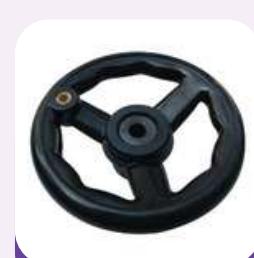

Three Spoke Hand Wheel



Sleeve Bush

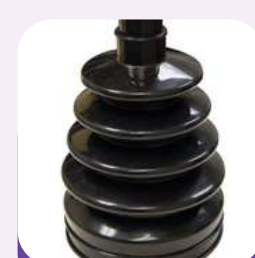

Axle botts



Stabilizer Bar Bushes

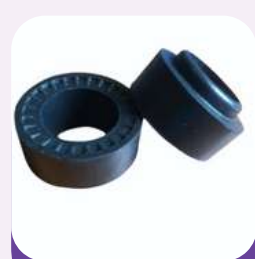

Rear Coil spring pads

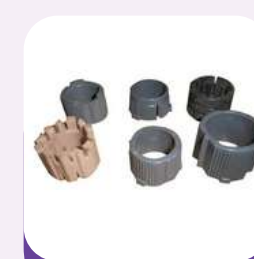

Steering Rack Bushes



Fixed Handle

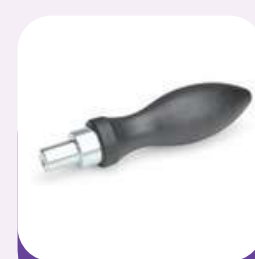

Revolving Handle

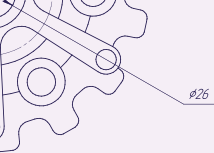

OUR PORTFOLIO | O-RING



**Oil Resistant
NBR**

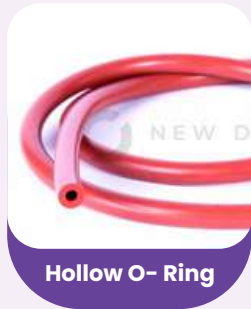

Hollow O- Ring



Silicone O-Ring



Vitron O-Ring



**EPDM Rubber
O ring**



**Neoprene
O-Ring**



**PTFE (Teflon)
O-Ring**



**Polyurethane
O-Ring**



**FEP Encapsulated
O-Ring**



**Auto engine
fan belts**

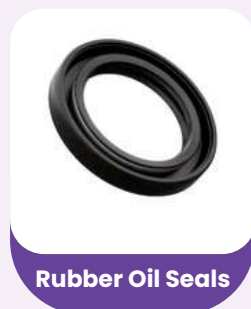

Rubber Oil Seals



Spring Washer



**Hydraulic Seal
Kits**



**Pneumatic Seal
Kits**

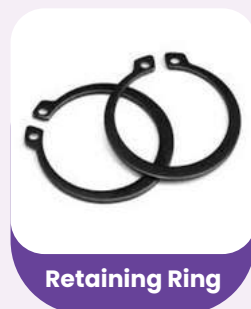

Retaining Ring

SWITCHES



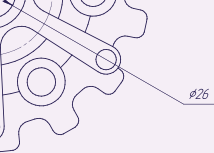

OUR PORTFOLIO

Switches



One Way Switch with Plate



Two Way Switch with Plate



Bell Push Switch with Plate



16 Amp Switch with Plate



16 Amp Two Way Switch with Plate



One Way Switch Mini



Two Way Switch Mini



Bell Push Switch Mini



One/Two Way Switch with Champion



16 Amp Switch Mini

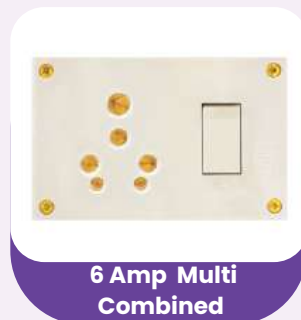

6 Amp Multi Combined



6 Amp Combined



MCB



RCD/RCCB



ELCB



Wifi CB

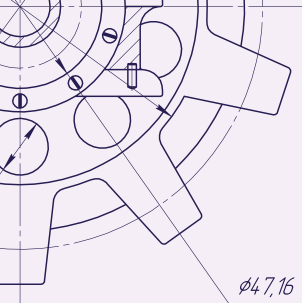

FRIGATE®
MANUFACTURING MADE EASY

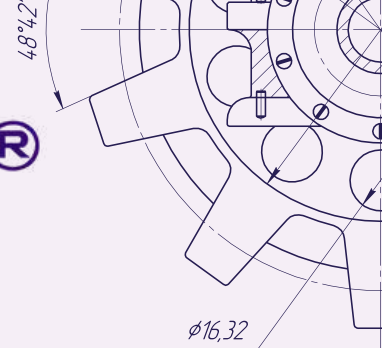

EXTRUSIONS



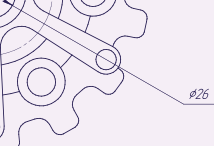

OUR PORTFOLIO | EXTRUSIONS

Heat Sink

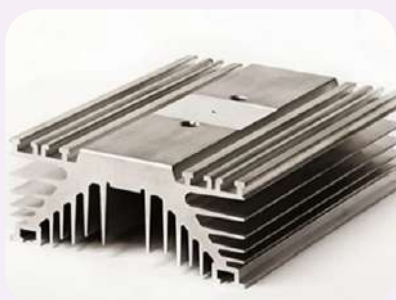

AHU Profile



Bars

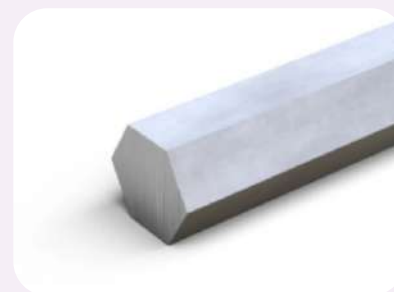

Tubes

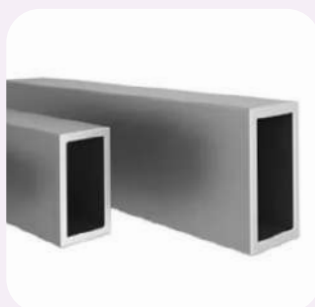

Angles

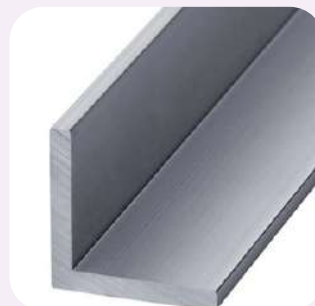



OUR PORTFOLIO | EXTRUSIONS

Door & Window Profile

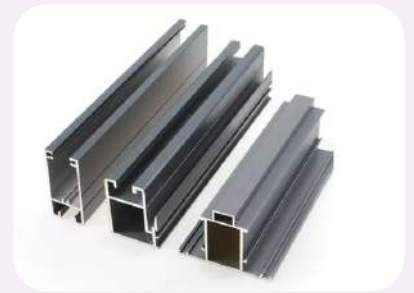

Curtain Wall Profile



Hardware Profile



Miscellaneous profile

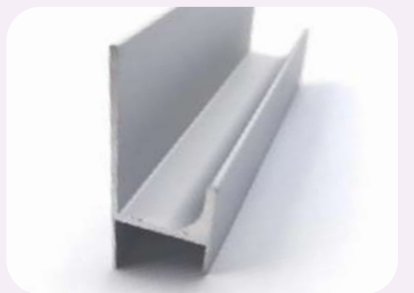

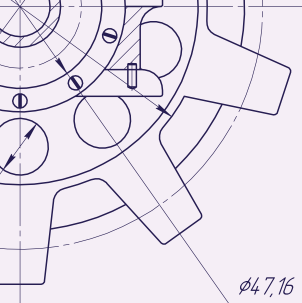

φ47,16

FRIGATE®

MANUFACTURING MADE EASY

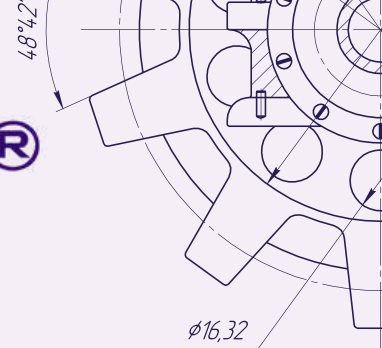

48°42'

φ16,32

HEAVY ENGINEERING



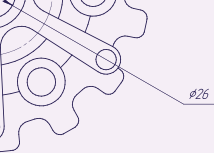

OUR PORTFOLIO



Any type of Steel Structures



PEB Structures



Pipe rack / Conveyor Structures



MS Gratings



Heat Exchangers



MS Tanks



SS Tanks



Hopper Silos/ Hopper tanks



Boiler Components

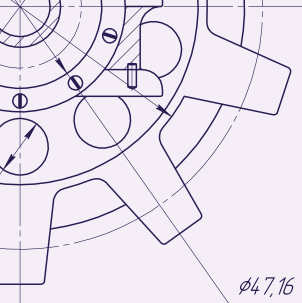

FRIGATE®
MANUFACTURING MADE EASY

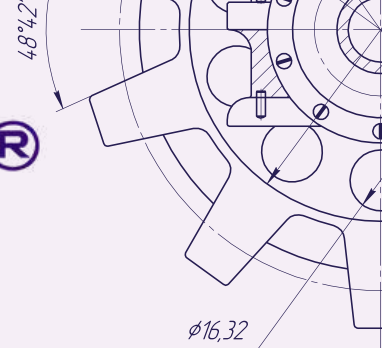

AUTOMOTIVE LIGHTING



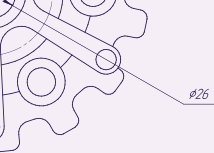

OUR PORTFOLIO | LIGHTING SOLUTIONS

TWO WHEELER-HEAD LIGHT



TWO WHEELER-TAIL LAMP



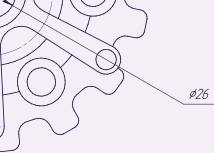

OUR PORTFOLIO | LIGHTING SOLUTIONS

FOUR WHEELER HEAD LAMPS & TAIL LAMPS

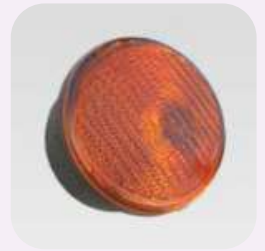
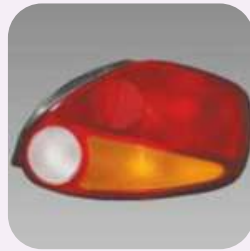

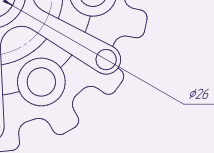

OUR PORTFOLIO | LIGHTING SOLUTIONS

TWO WHEELER EV-HEAD LIGHTS



TWO WHEELER EV-TAIL LAMPS



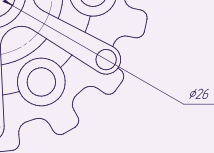

OUR PORTFOLIO | LIGHTING SOLUTIONS

TWO WHEELER - TAIL LAMPS

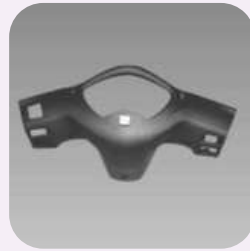

TWO WHEELER REAR VIEW MIRRORS



Valves, Couplings, Flanges, Spacers, Pipes & Fittings



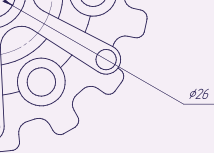

OUR PORTFOLIO | VALVES



Gate valves



Check Valves



Seat tilting valves



Strainer Valves



Butterfly Valve

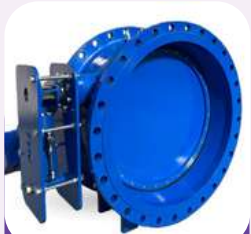

Hydraulic
Tilting Valve



Dismantling
Joint



Swing
Check Valve



Foot Valve



Ball Valve



Service Valve



Globe Valve



Disc - Check
Valve



Control Valve



Expansion
Joint



Diaphragm
Valve



Needle valve



Piston Valve



Pinch Valve



Balancing
Valve

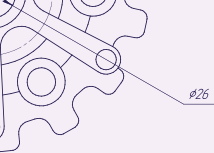

OUR PORTFOLIO | PIPE & FITTINGS

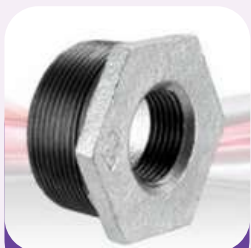

Hexagon Buss Fittings



Octagon Nipple Fittings



Hexagon Nipple Fittings



Beaded Plug Fittings



Plain Plug Fittings

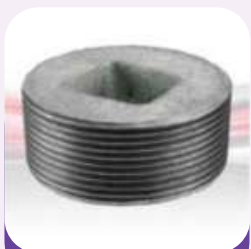

Countersunk Plug Fittings



Elbow Fittings

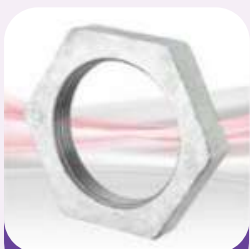

Backnut Fittings



Tee Fittings



M&F Tee Fittings



Cross Fittings



Socket Fittings



Cap Fittings



Bend Fittings

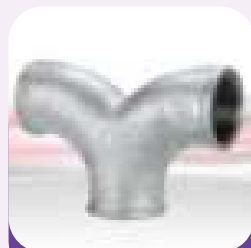

Twin Elbow Fittings



Union Fittings



M&F Union Fittings



Elbow Union Fittings



Pitcher Tee Fittings



All Types of Pipes

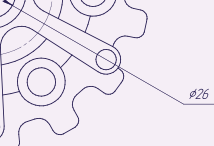

OUR PORTFOLIO | FLANGES, COUPLINGS & SPACERS



Split flange



Clamp Flange



Threaded & Counter Flange



Square Flange



Sock-Weld Flange



Weld neck Flange



Blind Flange



Slip-on flat Flange



Wheel Spacer



Spacers



Rigid Coupling



Sleeve Coupling



Split Muff Coupling



Gear Coupling



Fluid Coupling



Universal Coupling



Jaw Coupling



Below Coupling



Diagram Coupling



Fludex Coupling

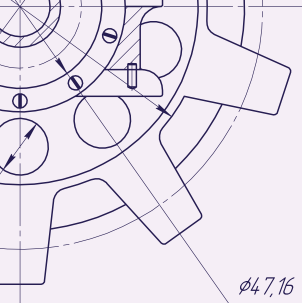

$\phi 47,16$

FRIGATE®

MANUFACTURING MADE EASY

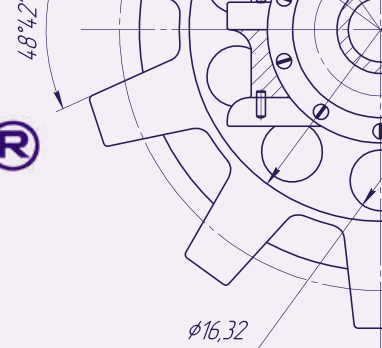

48,42

$\phi 16,32$

FASTENERS



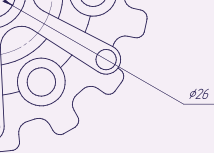

OUR PORTFOLIO

Screws

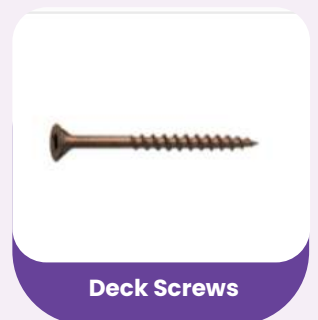
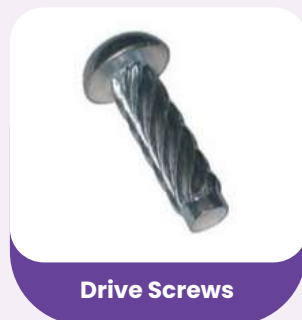
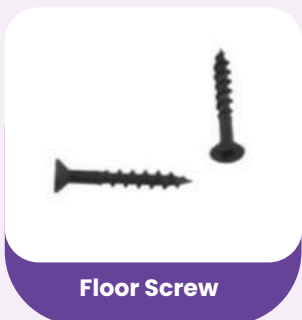
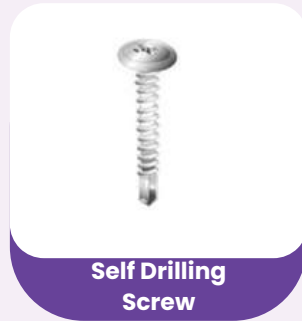
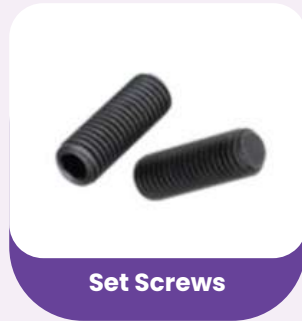
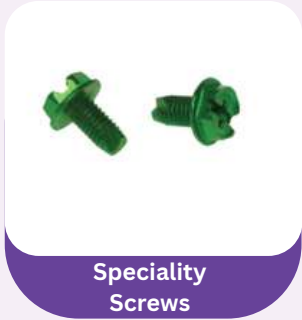

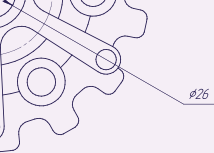

OUR PORTFOLIO

Anchors



Adhesive Anchor Accessories



Drive Anchors



Drive Pin Anchors



Drop - In Anchors Setting tool



Expansion Shields



Hollow Wall & Wallboard Anchors



Sleeve Anchors



Drop - In Anchors



Wall Anchors



Wedge Anchors

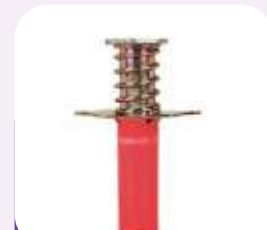

Miscellaneous Anchors



Screw Anchors

Bolts



Toggle Bolts



Carriage Bolts



Eye Bolts



U - Bolts

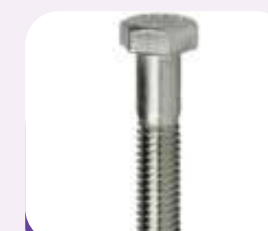

Hex Head Cap Screws



Machine Bolts



Structural Bolts



Tap Bolts

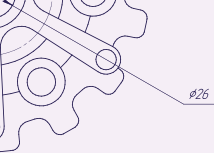

OUR PORTFOLIO

Nails



Finishing Nails



Sinker Nails



Specialty Nails



Roofing Nails

Nuts



Coupling Nuts



Eye Nuts



Flange Nuts



Hex Nuts



Lock Nuts



Specialty Nuts



Wing Nuts



Jam Nuts



Acorn Nuts

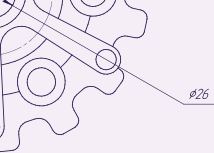

OUR PORTFOLIO

Washers



Fit Washers



Lock Washers



Rivet Washers



Speciality Washers



Nylon Washers

Pins



Hitch Pins



Spring Pins

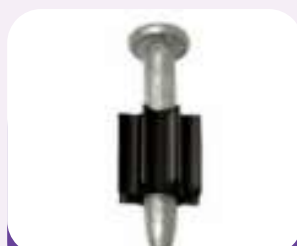

Drive Pins



Dowl Pins



Hairpin Cotter Pins

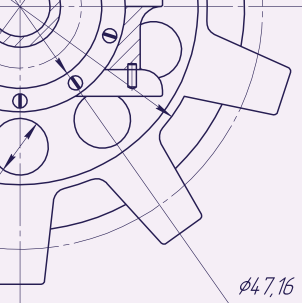

47,16

FRIGATE®

MANUFACTURING MADE EASY

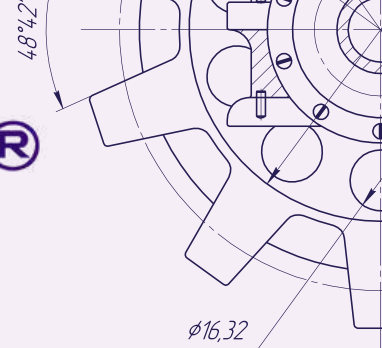

16,32

Automobile Performance And Aftermarket Parts



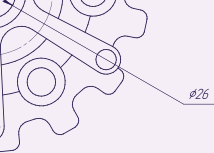

OUR PORTFOLIO | UTILITY METAL PARTS



Luggage Carrier



Head Lamp Grills



Bash Plate

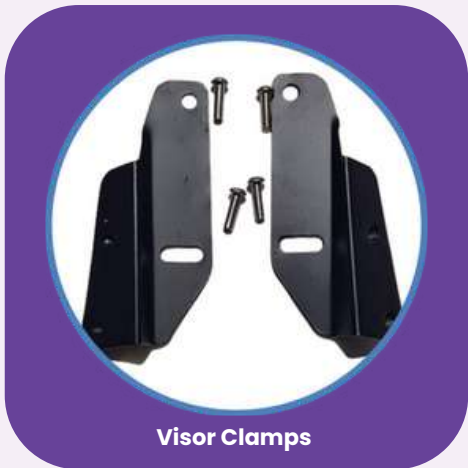

Visor Clamps



Radiator Grills



Performance Exhausts

PIPE BENT PARTS



Saddle Stay



Saree Guard



Luggage Carrier

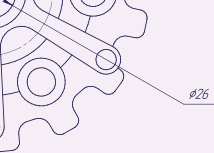

PLASTIC PARTS



Visors



Knuckle Guards



Rear Tyre Hug



Rear View Mirror



Mud Flap

RUBBER PARTS



Custom Handle Grips



O Rings



Foot Prg

LIGHTING ASSEMBLY



Aux Lamp Assy



Indicator Light Assy



Head Light Assy

PRIVATE LABELLED CONSUMABLES



Display Cluster Protector

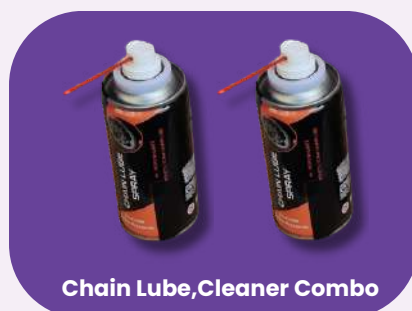

Chain Lube, Cleaner Combo



Helmet cleaners

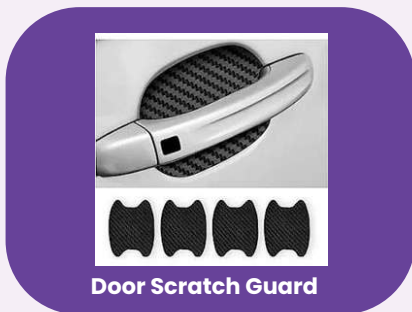

Door Scratch Guard

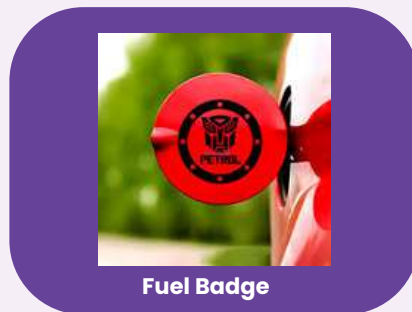

Fuel Badge



Door Guard

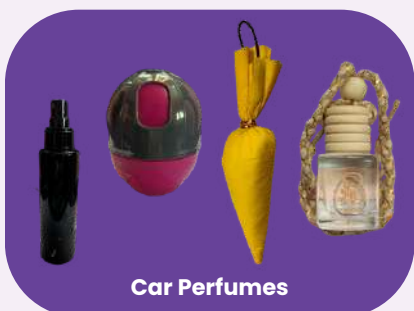

Car Perfumes

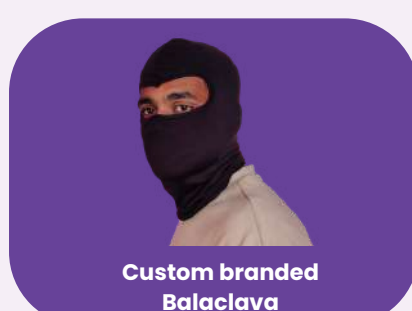

Custom branded Balaclava

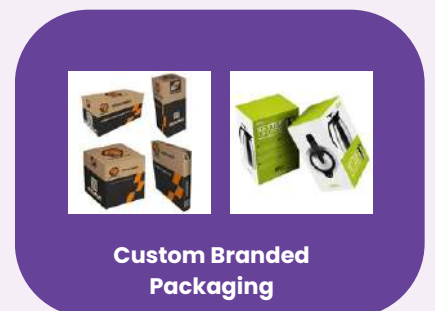

Custom Branded Packaging

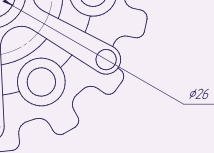

OUR PORTFOLIO | UTILITY PARTS



Side Foot Step



Door Guards



Spoiler



Wheel Cap/Cover



Luggage Carrier

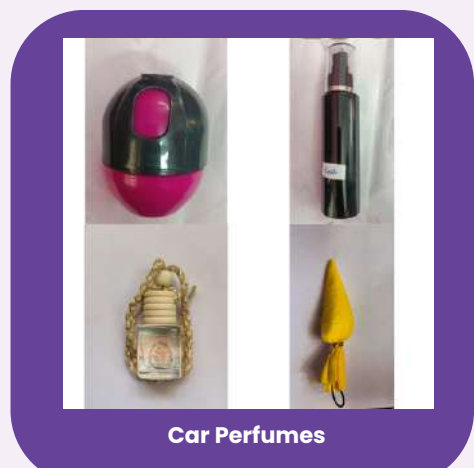

Car Perfumes



Armrest/Handrest



Roof Rail



Steering Food Tray



Dash Cams



Mechanical Creeper



Flag Post Clamp



Scratch Guards



Rain Visor



Grab Handles



Wheel Arch Cladding



Pedal Caps

ACCESSORY PARTS



Custom Grills



Scuff Plate



Mud Flap



Side Mirror



Hinge Step



Rear Bumper



Rear Nudge Guard

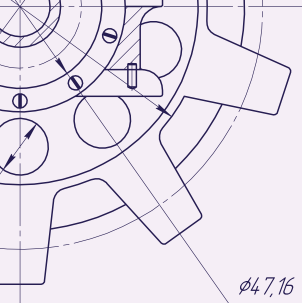

FRIGATE[®]
MANUFACTURING MADE EASY

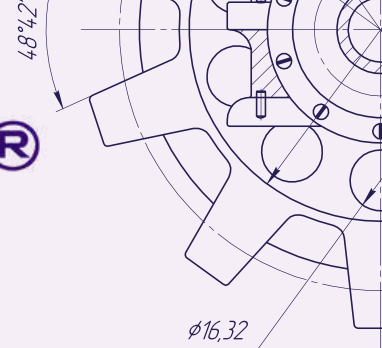

SOLAR PRODUCTS



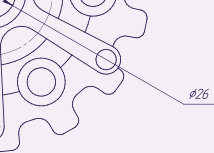

OUR PORTFOLIO

Solar Cables



Optic Fiber Cables



Flexible Cables



LV/MV/ HV XLPE Power Cables



Elastomeric Cables



Specialty Hybrid Cables

Solar structure & Foot pathway



Heat Shrink Sleeve



FRP Solar Panel Rooftop Walkway



Aluminum SolarMMS For RCC Roof

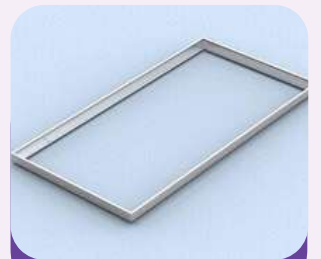

Solar Panel Aluminum Frame

Solar Junction Box



Solar Array Junction Box



Industrial Junction Box



Array Junction Box

Solar Tree



Solar tree

Solar Batteries



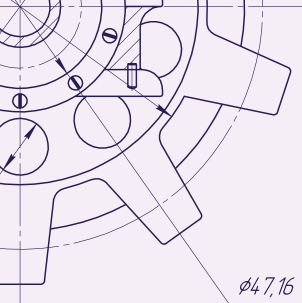

FRIGATE®
MANUFACTURING MADE EASY

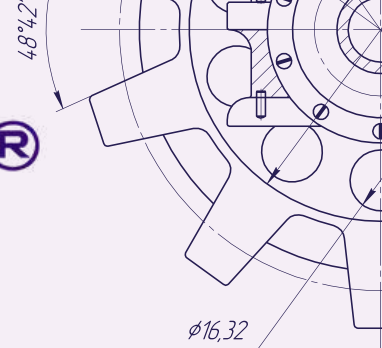

BASS COMPONENTS



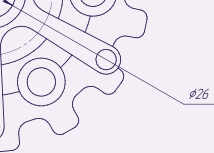

OUR PORTFOLIO | BRASS COMPONENTS



Swivel Connector



Male Elbow



Union Tee



Union Elbow



Union Joiner



Male Branch Tee



Female Hose Tail



Male Hose Tail



Cap



Hex Plug



Male/Female Adapter



Reducing Bush



Hex Socket



Reducing Socket



Reducing Nipple



Hex Nipple



Long Barrel Nipple



45° Male - Female Elbow



Pinch Valve



Female Tee

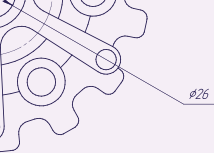

OUR PORTFOLIO | BRASS COMPONENTS



Female Cross



Male Run Tee



Lock Nut



Bulk Head Union



Compression Sleeve - Nylon



Neutral Link Bars



Compression Nut



Straight Union



Union Tee



Union Elbow



Female Connector



Male Connector



Male Elbow 90°



Tube Insert



Metric Tube Insert



Metric Compression Sleeve



Metric Compression Nut



Metric Compression Union



Metric Male Connector



Metric Male Elbow

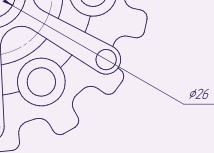

OUR PORTFOLIO | BRASS COMPONENTS



Flare Plug



Flare Cap



Short Flare Nut



Long Flare Nut



Flare Union



Flare Union Tee



Female Flare Connector



Male Flare Connector



Male Flare Elbow



Male Branch Tee



45° Male Elbow



Union-Imperial



Union Tee - Imperial



Male Connector - Imperial



Male Elbow 90 DEG - Imperial



Male Run Tee - Imperial



Male Branch Tee - Imperial



Male Elbow 45 DEG Imperial



Union - Metric



Union Tee - Metric

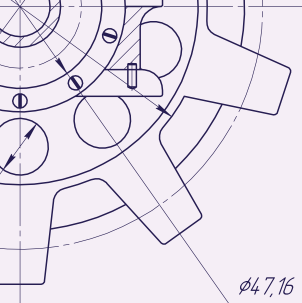

$\phi 47,16$

FRIGATE®

MANUFACTURING MADE EASY

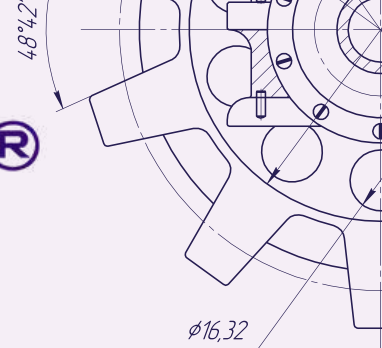

$\phi 16,32$

Mechanical Parts



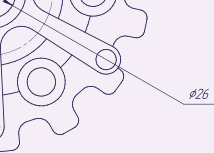

OUR PORTFOLIO

IMPELLER



Open Impeller



Semi Open Impeller



Closed Impeller

SHAFTS



Transmission Shaft



Crank Shaft



Spindle Shaft



Counter Shaft

GEARS



Spiral Bevel Gear



Helical Gear



Rack & Pinion



Internal Gear

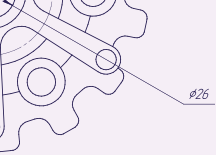

OUR PORTFOLIO



Pump Casing



Pump Mounting



Pulley



Engine Housing

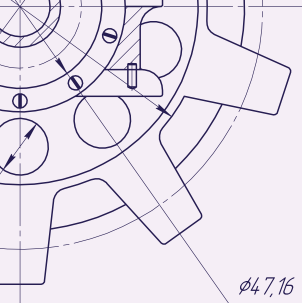

47,16

FRIGATE®

MANUFACTURING MADE EASY

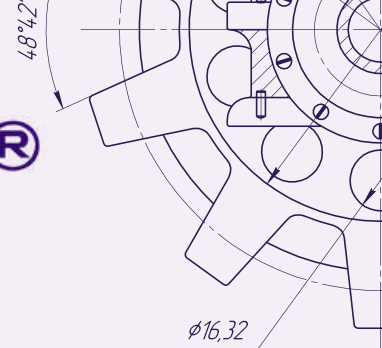

16,32

Packaging



OUR PORTFOLIO | CORRUGATED BOXES



Universal RSC



Top and Bottom Lid Type



Mono/Multi Color Printed

DUPLEX BOXES



Butterfly Type



Top & Bottom



Printed

DIE CUT



Die Cut Enveloped



Padding - Kraft/Duplex



L Angle Boards

STAND UP POUCHES



CANISTERS



BOTTLED



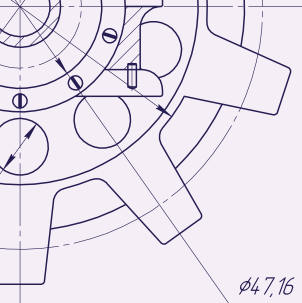

FRIGATE®
MANUFACTURING MADE EASY

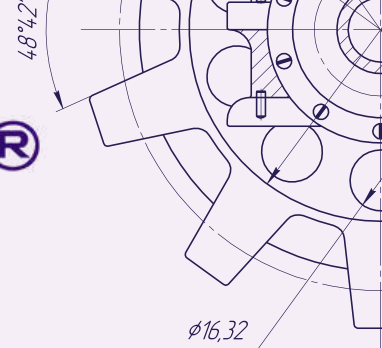

Contract Manufacturing



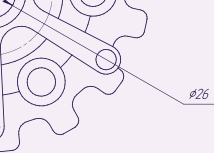

OUR PORTFOLIO | VALVES



**Power
Distribution Unit**



**EV Power
Charging**



TV Assembly



Belt Buckle



Setup Box



Chargers



**Smart Meter
Assembly**



IoT Devices



**Vending
Machine**



Robotics



Robots



**Energy Storage
Systems**



**Battery
Boxes**



LED Assembly



**Warehousing
Equipment**



**Medical
Equipment**

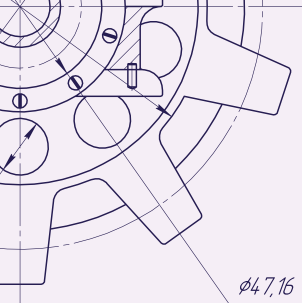

FRIGATE®
MANUFACTURING MADE EASY

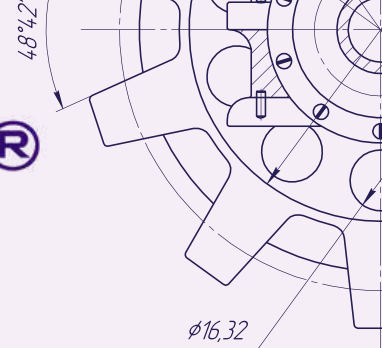

EMS & Semi-Conductors

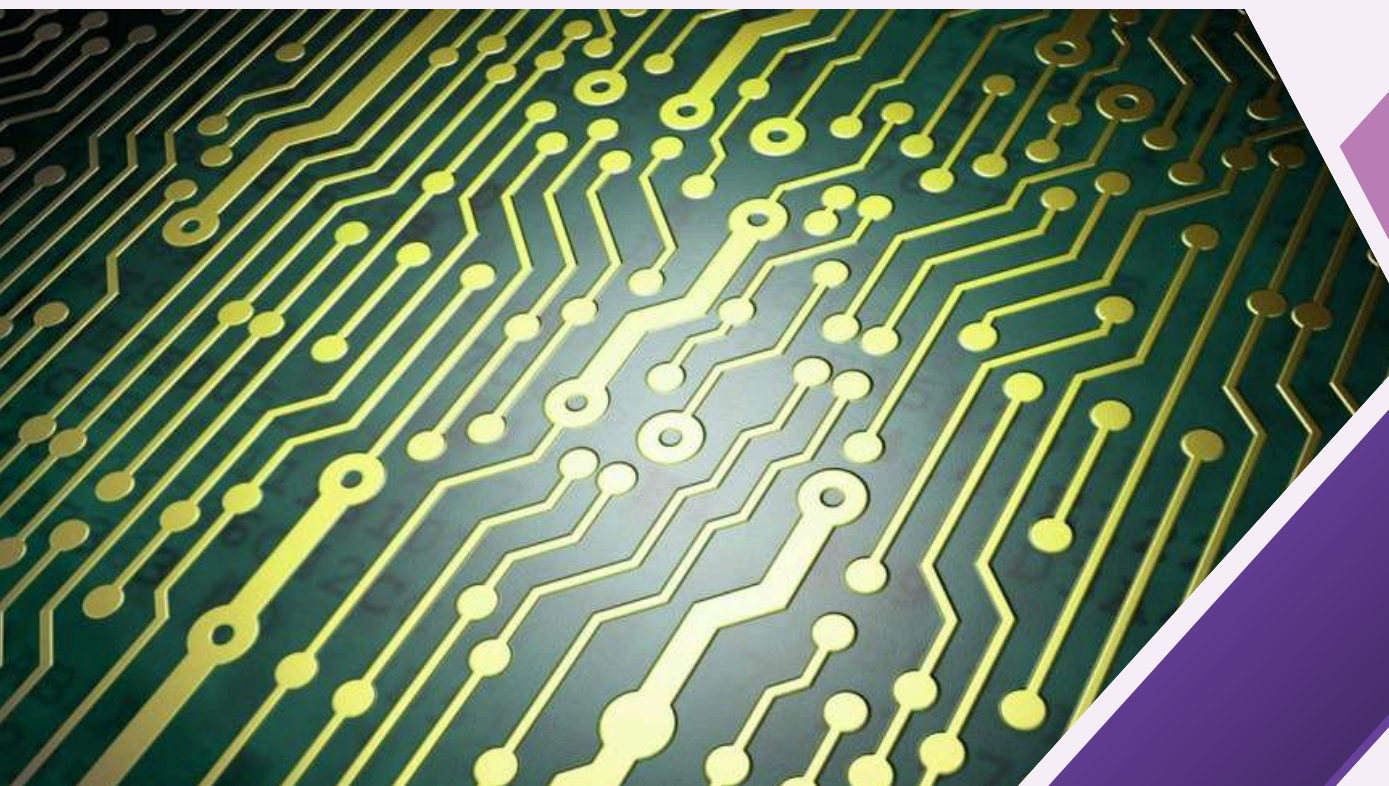

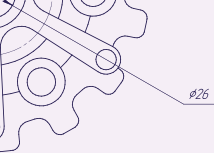

OUR PORTFOLIO | PCBs



Single-layer PCBs



Double-layer PCBs



Multi-layer PCBs



Flexible PCBs

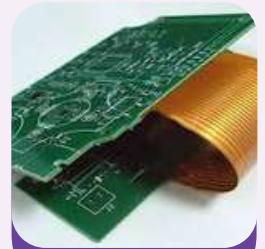

Rigid-flex PCBs

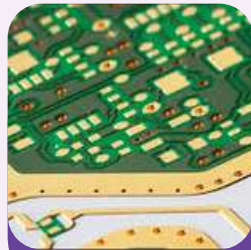

High-frequency
PCBs



Metal core
PCBs

OUR PORTFOLIO | PCB ASSEMBLY

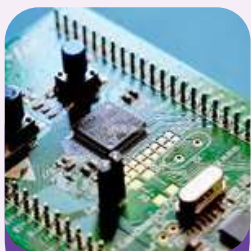

SMT



THT

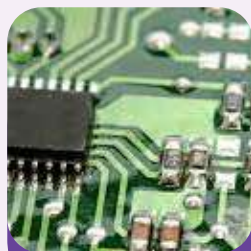

Mixed
Technology

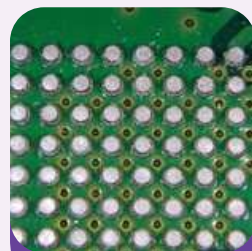

Ball Grid Array

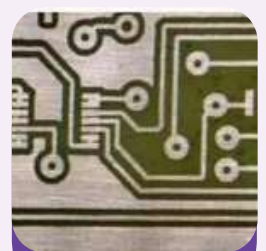

Fine pitch

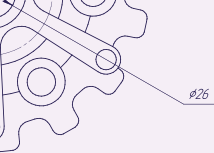

OUR PORTFOLIO | BOX BUILDING & ENCLOSURES



Drone Frames



Smart Watches Assembly



Cluster Assembly

OUR PORTFOLIO | CONNECTORS & WIRING HARNESSES



Wiring Harness



Socket Fittings



Terminal Blocks



Crimping & Termination



Over Moulding

COMPONENT SOURCING AND PROCUREMENT

SEMICONDUCTORS (ACTIVE & PASSIVE)



Diodes



Transistors



SCR



Inductors



Thermistor



Capacitors

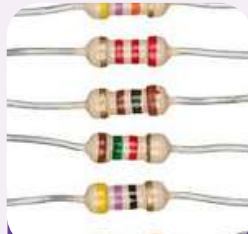

Resistors



Microcontrollers

*Many more

USER INTERFACE & COMMUNICATION MODULES



OLED / LCD Displays



Custom Displays



Touch Screen Displays



5G / 4G Cellular modules



Bluetooth Module

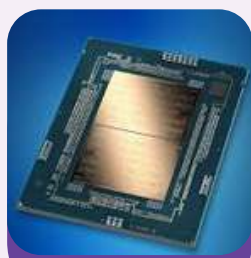

Gen AI Chips



LoRa Module

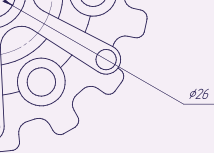

OUR SUCCESS STORIES



Made In India LED TV



Sheet Metal Kiosk with Display for Billing Desk

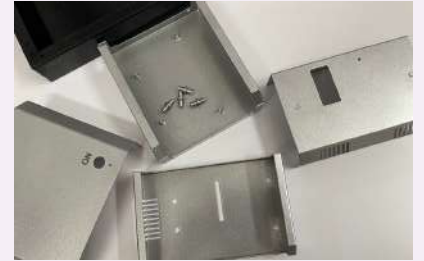

Enclosures



WEIGHING SCALE



TYRE INFLATOR



Kiosk with LED TV for Retail Stores



EGG BOILER

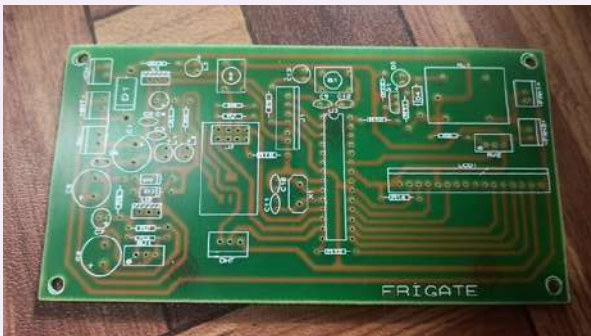

Multi-Layer PCB



Smart Band



MULTI-PURPOSE KETTLE



LED TV ASSEMBLY LINE



INDUCTION STOVE ASSEMBLY



TOWER FAN ASSEMBLY LINE

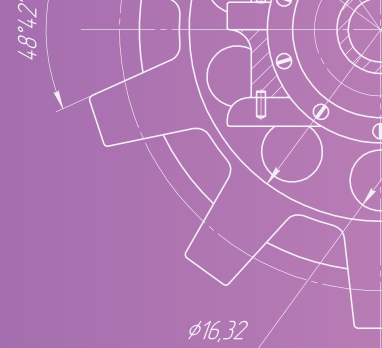
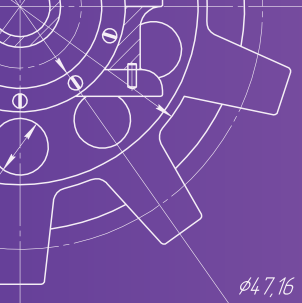

THANK YOU

E-Mail
manufacture@frigate.ai

Contact No
+91 9486164606